



LEGAL NOTICES

© IMECAR. All rights reserved.

Unless otherwise stated, all names, logos, trademarks, and service marks referenced in this document are the property of IMECAR or are used under license by IMECAR.

The information contained in this document is provided for informational purposes only. IMECAR assumes no responsibility or liability for any damages, losses, or injuries resulting from the use of, or reliance on, the information herein.

IMECAR reserves the right to modify, update, or revise this document and its contents at any time without prior notice.

USER MANUAL

This User Manual has been prepared by IMECAR engineers for the Battery Pack. Please read this installation and operation manual thoroughly before using the battery pack. For assistance with any issues not addressed in this document, contact IMECAR engineers directly or via email through our website: <https://www.imecar.com>.



TABLE OF CONTENTS

1	SAFETY	4
1.1	General Safety Instructions	4
1.2	Warning Symbols	5
1.3	Warning and Hazard Labels	5
2	EQUIPMENT REQUIREMENTS	6
3	PRE-INSTALLATION INSPECTION	6
4	CABLE SELECTION	6
5	INSTALLATION AND STORAGE ENVIRONMENT	7
6	CAN BUS (COMMUNICATION PROTOCOL)	7
7	BATTERY PACK INTRODUCTION	8
7.1	Battery Pack Safety Labels	8
7.2	Cable Connections	9
8	MOBILE APPLICATION	12
8.1	Application Download and Access	12
8.2	Home Screen Interface	13
8.3	User Login	15
8.4	Cell and Temperature Information	16
8.5	Alarms and Warnings	17
8.6	About Page	18
8.7	Device List – Viewing Over Wi-Fi	19
9	CHARGING PROCESS	20
9.1	Charging Types	21
10	STORAGE	21
10.1	State of Charge (SOC) Calibration for Long-Term Storage	22



Figures

Figure 1	10.5 kWh Battery Pack External View	8
Figure 2	Battery Pack Cable Connection Points	9
Figure 3	Battery Pack Cable Connections	10
Figure 4	Optional On/Off Button.....	11

Tables

Table 1	Environmental Conditions	7
Table 2	Storage Temperature.....	21



1 SAFETY

1.1 General Safety Instructions

RULES	CAUTION
Always wear appropriate personal protective equipment (PPE), including eye protection and gloves.	Never wear jewelry or other metallic objects when working on or near the battery pack.
Always use insulated tools when performing work on the battery pack.	Never place any objects on the battery pack.
Always keep sparks, open flames, and sources of static electricity away from the battery pack.	The battery pack should be stored at approximately 30% state of charge (SOC). Ensure this value is maintained.
Always use appropriately sized, short cables to minimize voltage drop.	The battery pack temperature rises if the maximum charging current is exceeded. Never exceed the specified maximum charging current to ensure battery health and longevity.
Always ensure the charger is configured according to the recommended settings.	Never dispose of batteries as household waste. Recycle them in accordance with applicable regulations.
Always ensure that chargers are turned off or disconnected before performing work on the battery pack.	The battery pack may only be opened by IMECAR personnel. Unauthorized opening will void the product warranty.
Always follow the product warning labels and the battery pack instruction manual provided by IMECAR.	Do not use wet or dry pressure washers to clean the battery pack. Do not immerse the battery pack in water. Always protect the battery pack from contact with liquids.
Never subject the battery pack to physical damage, including drilling, dropping, crushing, burning, shaking, hammering, or improper terminal connections. Battery packs exposed to these conditions, even if no visible damage is present, must not be used.	Never short-circuit the terminals of the battery pack.
Always install the battery pack with the power off.	Never overcharge or over-discharge the battery pack.



1.2 Warning Symbols

Important warnings used in this document are listed below.









- 

Failure to observe this warning may result in serious injury or even death to personnel near the battery pack or during its handling.
- 

If ignored, this may result in serious injury.
- 

It may cause damage to the battery pack.

1.3 Warning and Hazard Labels

	<p>The “Refer to User Manual” symbol indicates the importance of the document information. Do not install the battery pack before reading this document. Make sure you understand the warnings, installation steps and other information, otherwise unintentional actions may cause injury or death.</p>
	<p>The “Warning” symbol indicates danger. Failure to observe or incorrect application of procedures and practices may result in injury or death of installation personnel. Only after the specified conditions have been fully understood and fulfilled may the operation accompanied by the “electrical hazard” symbol be carried out.</p>
	<p>The “Caution” symbol indicates danger. Failure to observe or incorrect application of procedures and practices may result in damage or destruction of the product. Only after the specified conditions have been fully understood and fulfilled, the operation accompanied by the “caution” symbol can be carried out.</p>
	<p>“Electrical hazard” indicates danger. Failure to observe or incorrect application of procedures and practices may result in injury and death of installation personnel. Only after the specified conditions have been fully understood and fulfilled, the operation indicated by the symbol “Voltage hazard” may be carried out using personnel isolation equipment.</p>
	<p>The symbol indicates electrical hazard. Do not make physical repairs to the battery pack.</p>
 <p>Li-Ion</p>	<p>Indicates the collection and recycling of battery packs. The collection and recycling of battery packs contributes to environmental protection and the conservation of material resources and enables the recovery of valuable materials.</p>
 <p>Li-Ion</p>	<p>The symbol indicates Li-ion battery waste. Do not dispose of products containing Li-ion batteries with general products.</p>
	<p>The symbol indicates moisture protection. The product is affected by moisture. Therefore, make sure that the installation prevents moisture and that the system is located in a moisture-free, dry environment.</p>



2 EQUIPMENT REQUIREMENTS

Before performing installation or maintenance of the battery pack, ensure that the following equipment is available and that all required safety precautions have been taken.

Equipment:

Insulated Hand Tool Set	Fasteners
Protective Goggles	Protective Clothing
Insulated Torque Wrench	Insulated Workbench
Insulated Gloves	Firefighting Equipment



Check that the equipment and tools used during installation are in good working condition.

3 PRE-INSTALLATION INSPECTION

Inspect the battery pack for visible damage, including cracks, dents, deformation, or other obvious anomalies.

If any issues are identified with the battery pack, contact IMECAR Technical Support or your authorized distributor. In the event of shipping-related damage, contact the shipping carrier.

Follow all procedures outlined in this User Manual for proper installation, operation, and storage.

If you have any questions or concerns regarding the installation or operation of the battery pack, contact IMECAR Technical Support prior to the occurrence of any issues.

4 CABLE SELECTION

Cables must be properly sized to carry the expected electrical load and be of sufficient length and flexibility to prevent unintended mechanical stress on the connector interfaces.



5 INSTALLATION AND STORAGE ENVIRONMENT

Installation and storage of the battery pack must be performed in a clean, dry, and moisture-free environment. Any contact with liquids must be avoided.

The recommended environmental conditions for battery pack installation are listed in Table 1.

The accumulation of dust or sand inside the equipment may result in premature damage. Therefore, the environmental conditions listed in the table below should be considered when selecting the battery pack installation site.

Table 1 Environmental Conditions

Environmental Conditions	Recommended Range
Environmental Temperature	-20°C – 55°C (-4°F – 131°F)
Humidity	80% relative humidity, no condensation
Dust Level	$\leq 1 \text{ mg/m}^3$
Abrasive Materials	The environment must not contain pollutants such as salt, acid, smoke, etc.
Vibration	$\leq 1.5 \text{ mm/s}$

6 CAN BUS (Communication Protocol)

The battery pack is equipped with a CAN communication interface that provides real-time current, temperature, and voltage data. Any malfunctions or fault conditions are detected and reported via CAN communication.



7 BATTERY PACK INTRODUCTION

Before installing the battery pack, carefully review this introductory section. This section provides an overview of the battery pack layout and identifies the locations of the power connection ports, communication ports, control interfaces, air valve, and mounting points as shown in the figure below.

The battery pack is equipped with HV (+), HV (-), and Low Voltage (LV) communication socket outputs. All cable connections shall be connected to the corresponding sockets as indicated in the figure. Incorrect or improper connections may result in system malfunction, equipment damage, or safety hazards.

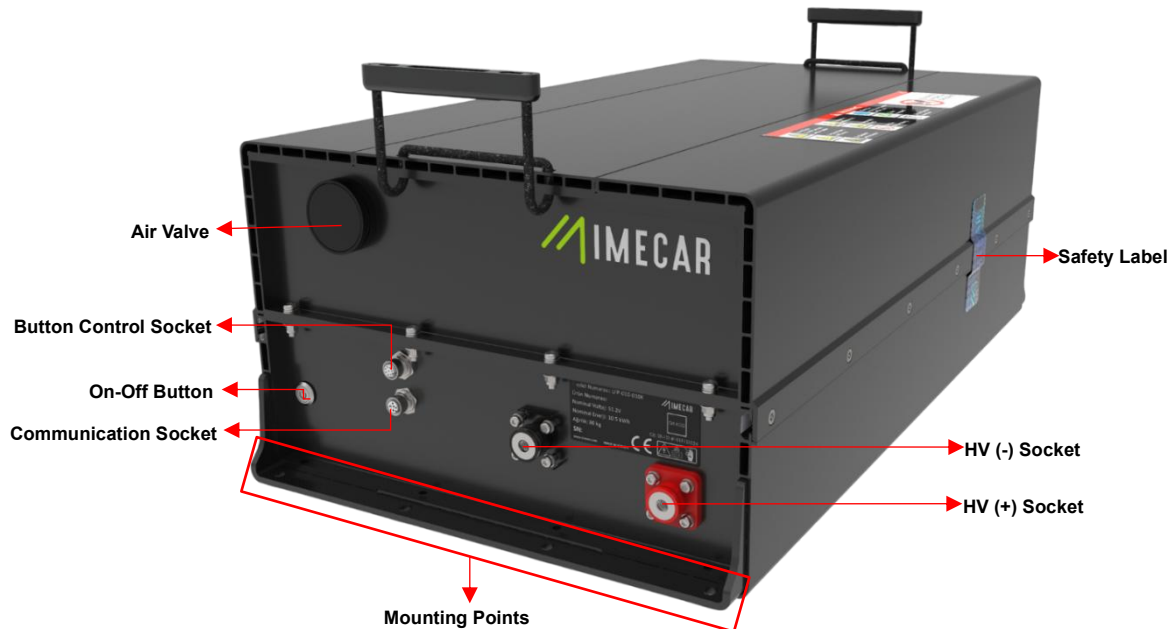

Figure 1 10.5 kWh Battery Pack External View



- Cable connections are critically important. Incorrect connections may cause severe damage to the battery pack or any components connected to it. This can also lead to serious injury or death to individuals near the component.
- The battery pack must be installed by qualified and authorized personnel only.

7.1 Battery Pack Safety Labels

As shown in *Figure 1 – 10.5 kWh Battery Pack External View*, the battery pack is equipped with a Safety Label for user protection and hazard awareness.

- The Safety Label indicates that the battery pack contains high-voltage and energy storage components and must be handled with care.
- Only authorized and qualified personnel are permitted to install, service, inspect, or perform any intervention on the battery pack.
- The Safety Label is provided solely for safety and warning purposes and forms an integral part of the product's safety system.
- The Safety Label must not be removed, damaged, altered, or covered under any circumstances.
- If the Safety Label becomes damaged or unreadable, the battery pack must not be operated until the label is replaced.

Failure to comply with the instructions indicated by the Safety Label may result in serious injury, electric shock, fire hazard, or voiding of the product warranty.



7.2 Cable Connections

Refer to the numbered components shown in the figure when connecting the cables.

All connections shall be performed only by authorized personnel and with the battery pack powered OFF.

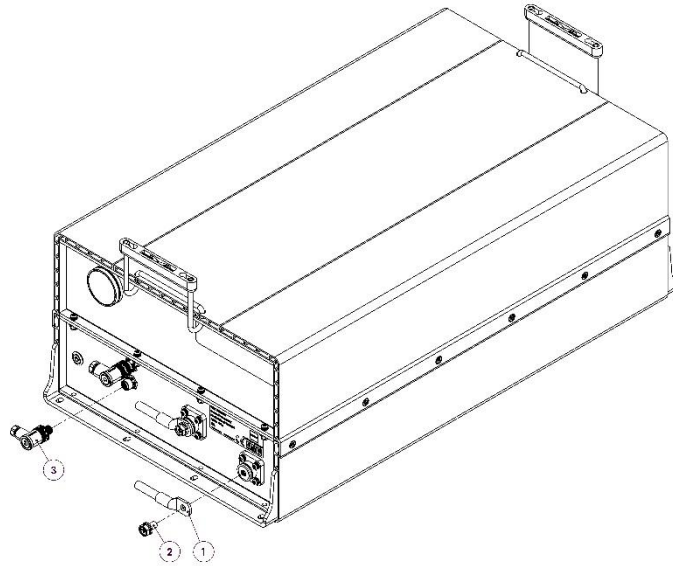

Figure 2 Battery Pack Cable Connection Points

➤ HV Power Terminal

This is the high-voltage power terminal (1, 2) on the battery pack where the main power cable is connected.

➤ HV Power Cable Lug / Fastener

Attach the power cable lug to the HV terminal (1) and tighten the fastener securely.

Make sure the connection is fully seated and does not move.



➤ Communication Socket

Connect the communication (CAN) connector to this socket (3). Ensure it is fully inserted and locked.

After completing connections, verify that all connectors are secure and cables are not under tension before powering ON the battery pack.

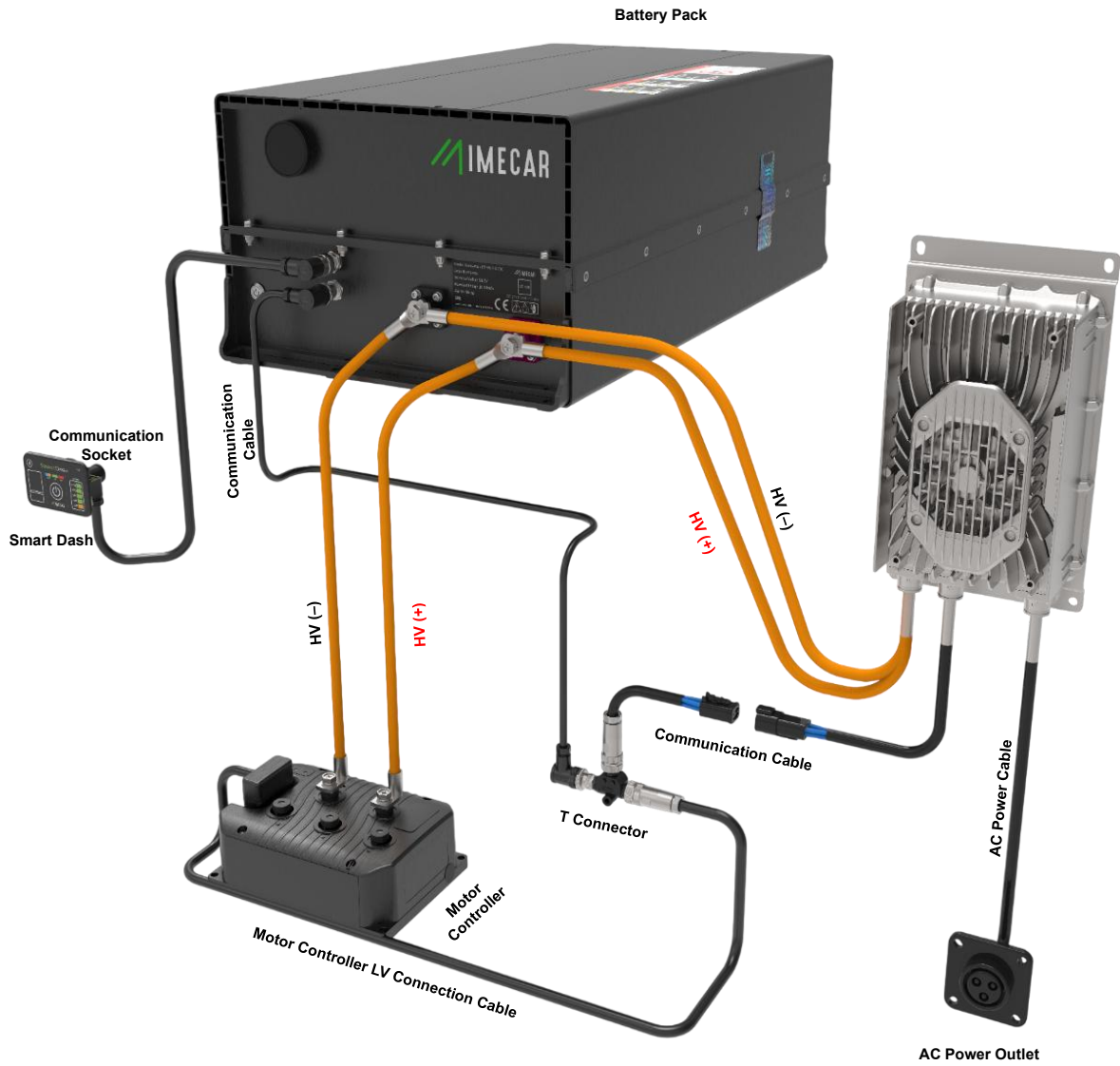

Figure 3 Battery Pack Cable Connections



➤ **Optional On/Off Button**

As an alternative to the Smart Dash unit, an optional On/Off Button may be supplied upon customer request.

This component is intended for systems where the Smart Dash is not installed.

The On/Off Button enables manual activation and shutdown of the battery pack.

The cable assembly connects directly to the battery pack control/communication port.

For wiring and connection details, refer to Section 7.2 - Cable Connections.

This product is optional and provided only upon request.

If the optional On/Off Button is used, installation and operation must be performed strictly in accordance with the instructions in this manual.

Failure to follow the installation instructions may result in system malfunction or equipment damage.



Figure 4 Optional On/Off Button



8 MOBILE APPLICATION

The Smart Dash mobile application is used to monitor battery status, view system data, track alerts, and manage device settings. The application connects to the Smart Dash device via Bluetooth and Wi-Fi.



8.1 Application Download and Access

Download the mobile application using the links below.

- **Android:** Google Play Store



- **iOS:** App Store



The application is compatible with both Android and iOS operating systems.



8.2 Home Screen Interface

When the application is launched, a Bluetooth connection must first be established.

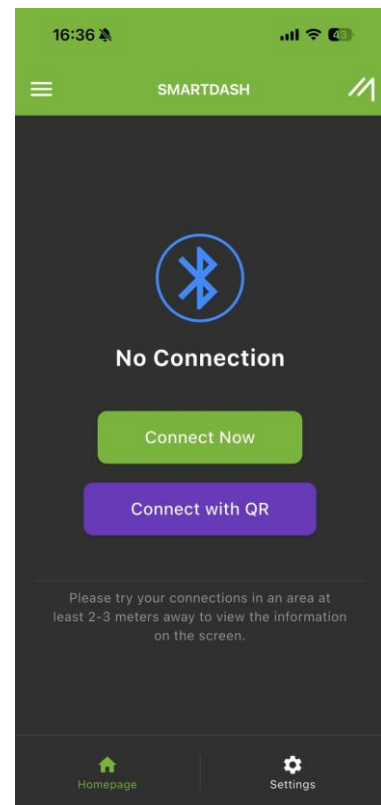



The login screen interface is shown in the figure. The interface allows real-time monitoring of key parameters, including voltage, current, temperature, and power.

From this screen, the instantaneous status of the connected system can be quickly observed.

The lower section displays the BMS clock of the connected device. Use the “**Pair**” button to synchronize the BMS clock with the mobile device time.

In the Wi-Fi section located below, the network to which the device is connected is shown. If the device is not connected to a Wi-Fi network, the corresponding button becomes active to initiate a connection.

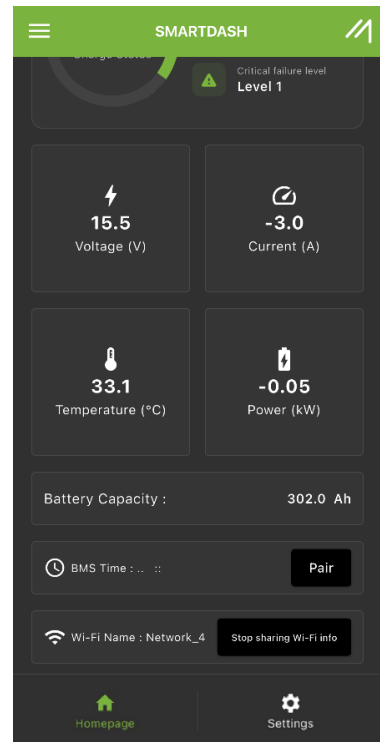
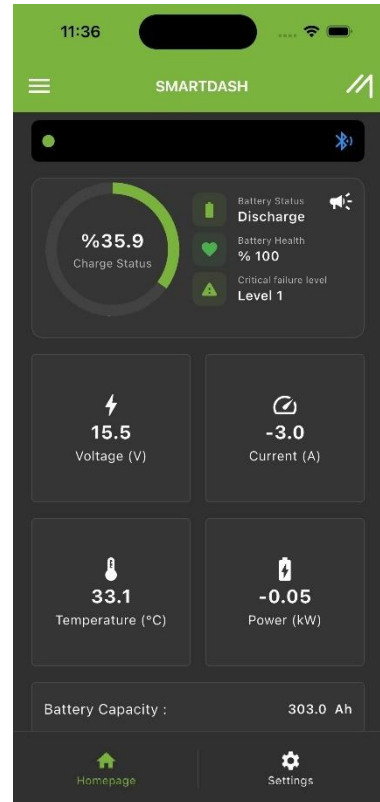



8.3 User Login

User login is required to access detailed data. To log in, Technical Mode must be activated. After Technical Mode is enabled, users can sign in through the application using their username and password.

Note: The username and password will be provided by IMECAR.

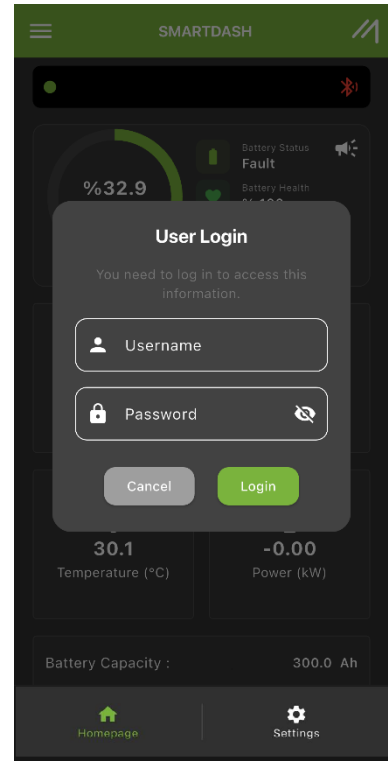
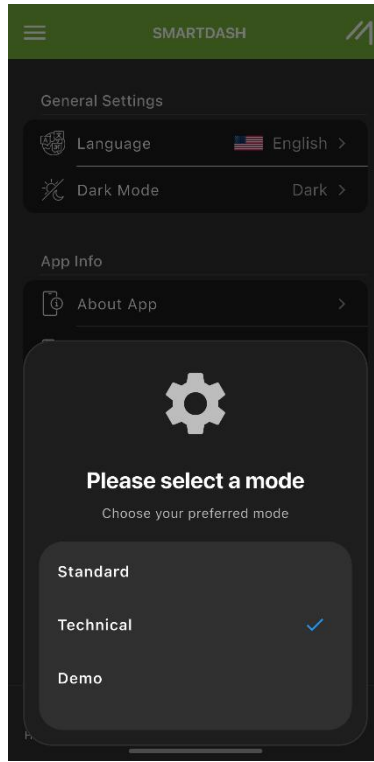
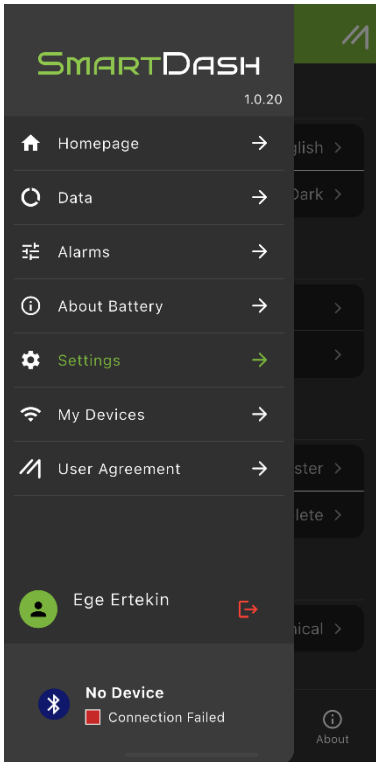



8.4 Cell and Temperature Information

This interface provides detailed information about the connected BMS, including cell voltages, balancing circuit temperatures, and MOSFET temperatures.

Further down the screen, cell temperature data is displayed.

Note: If the user does not log in, these tabs will not be active. Please log in to access detailed information.

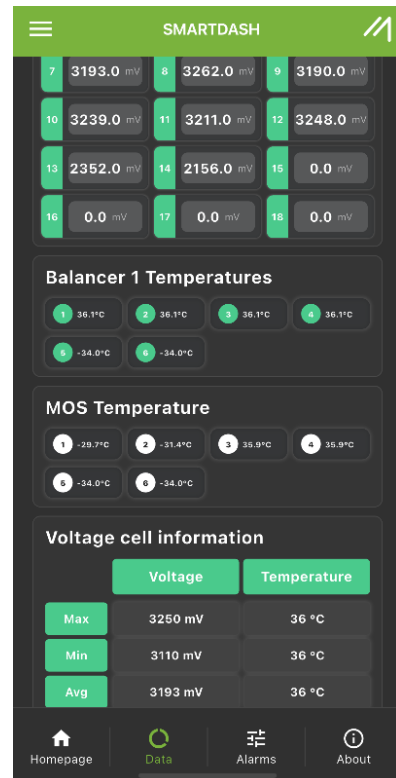
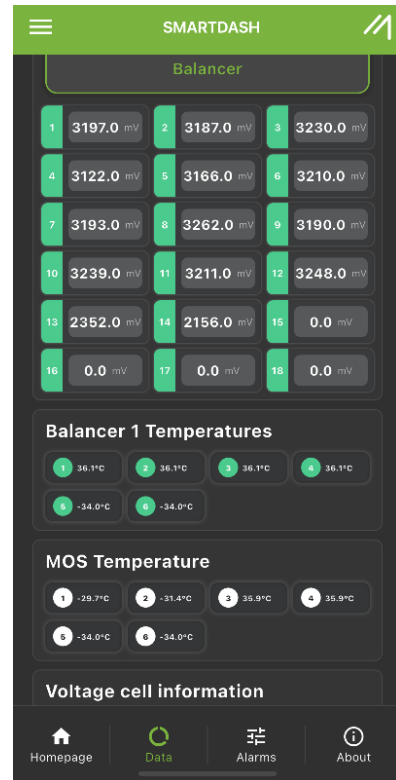



8.5 Alarms and Warnings

On the Alarms page:

- Active faults and warnings are displayed in real time.
- Warnings are categorized by severity using green, yellow, and red color indicators.

When the “Save BMS Log” button at the bottom of the page is activated, general data from the connected device is collected and can be shared as shown in the image below.

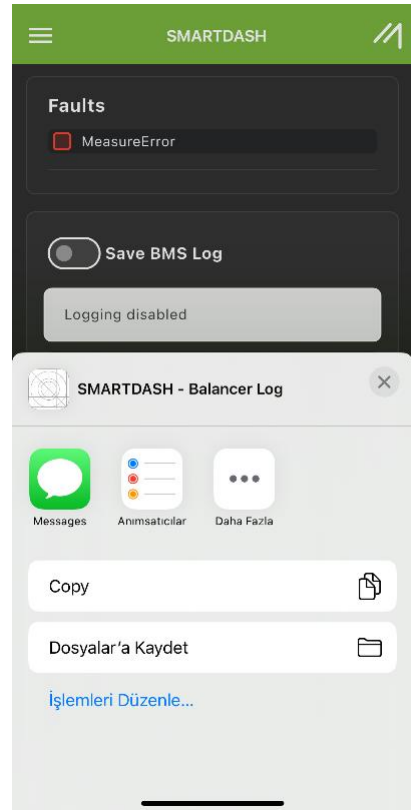
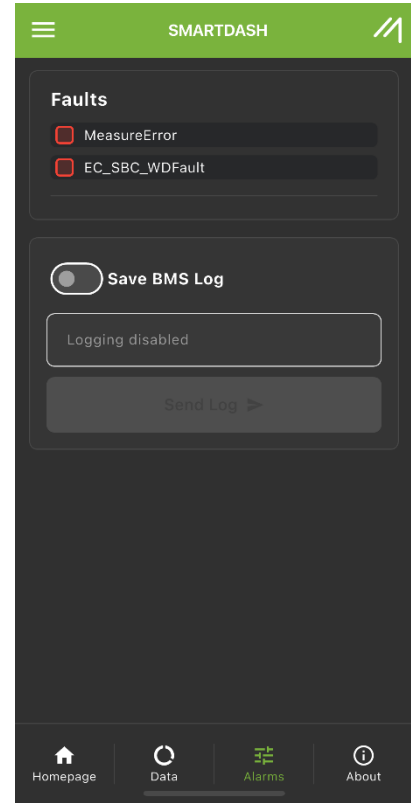



8.6 About Page

The following information is displayed on this page:

- BMS serial number
- Firmware version
- Number of cells
- Charge cycle count

In addition, the mobile applications:

- Version information
- Initial installation date

can also be viewed on this page.

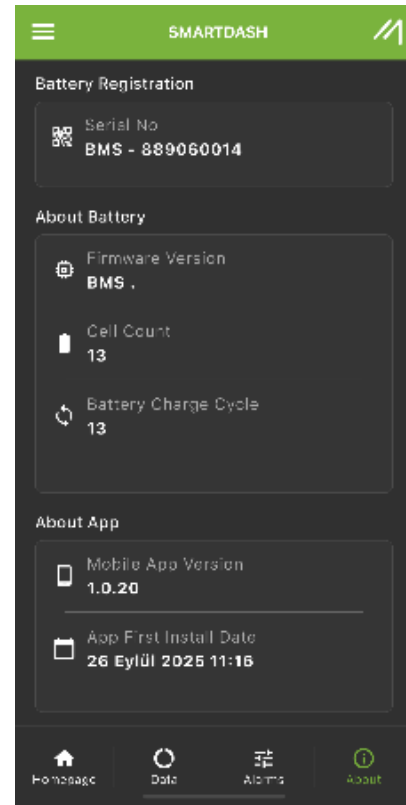



8.7 Device List – Viewing Over Wi-Fi

This screen lists all of your devices collectively when their Wi-Fi connections are active.

- Devices can be monitored over Wi-Fi.
- Pressing and holding on a device opens the detailed view, similar to when connected via Bluetooth.

The username and password are the same as those used for the web platform.

Web Access Address: <https://bmsmanager.imecar.com/>

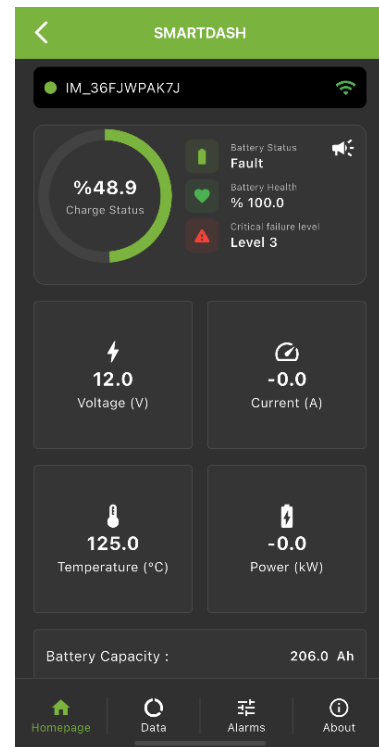
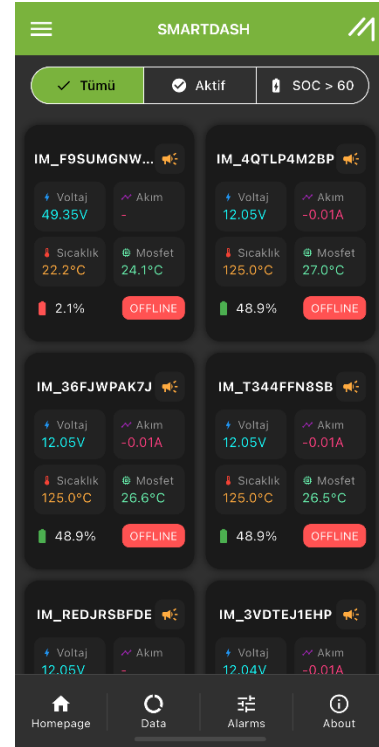



9 CHARGING PROCESS

In accordance with dangerous goods transportation safety procedures, battery packs are charged to approximately 30% state of charge (SOC) prior to shipment. Upon arrival at the customer's facility, each battery pack must first undergo a physical inspection followed by functional testing. After these steps are completed, the battery pack may be transferred to the production or storage area.



If the battery pack state of charge (SOC) drops to 30% or below, it should be recharged immediately.

- Before initiating the charging process, ensure that the charging station operates within the specified voltage range.
- Connect the charger positive (+) and negative (-) terminals to the corresponding HV positive (+) and HV negative (-) terminals on the battery pack.
- Key factors to consider during the charging process include the battery's required current and voltage limits, the battery state of charge (SOC), and the ability to terminate charging in the event of a fault.
- Ensure that the charging cables have an appropriate conductor cross-sectional area for the required current.



When connecting or disconnecting during charging, apply force only to the connector body. Do not pull or apply force to the cable.



- Do not move the battery pack while charging.
- Avoid exposure of the battery pack or charger to moisture or liquids. Protect the charging cable from damage or pinching.
- Use only the charger specifically designated for this battery pack. Use of any other battery or charger may result in damage, render the product inoperable, and void the product warranty.



9.1 Charging Types

Electric vehicle (EV) charging is primarily determined by the design and operational characteristics of the battery pack. In general, EV charging is classified into two main categories: alternating current (AC) charging and direct current (DC) charging. AC charging is typically associated with lower power levels and relies on the vehicle's onboard charger, whereas DC charging delivers higher power directly to the battery pack through offboard charging equipment. Depending on the battery pack capacity and the vehicle's charging architecture, either AC charging, DC charging, or a combination of both may be utilized.

When direct current (DC) power is not available from the charging source, the onboard charger (OBC) is utilized. The primary function of the OBC is to convert incoming alternating current (AC) power into direct current (DC) and deliver it to the battery pack. The OBC is an integrated component of the electric vehicle and enables the battery pack to be charged using DC power generated internally from an AC supply.

10 STORAGE

The battery pack undergoes self-discharge when not in active use, such as during storage or when the vehicle is parked, due to the inherent chemical properties of the battery cells.

If the battery pack will not be used for an extended period, it should be placed in storage. Recommendations for appropriate storage conditions are provided below.

Temperature

Exposure to extreme temperatures can damage the battery pack. High temperatures accelerate battery discharge.

- The battery pack must not be exposed to temperatures above 60°C (140°F) or below -30°C (-22°F).
- The battery pack must not be stored outdoors or exposed to direct sunlight.
- The battery pack must not be stored in environments subject to rapid temperature fluctuations.
- The battery pack must not be stored on damp or wet surfaces.

The storage temperature ranges and their associated effects are shown in the table below.

Table 2 Storage Temperature

1 month or less	30–50% SOC, -25 – 50°C (-13 – 122°F), ≤ 85% RH
More than 1 month	30–50% SOC, 0 – 35°C (32 – 95°F), ≤ 85% RH
Self-Discharge rate	100% SOC, 20 – 25°C (68 – 77°F), ≤ 4% per month

Humidity

Humid air can create a risk of short circuits due to condensation forming between the terminals.

- The optimum humidity for battery packs is 50%.
- The relative humidity should not be more than 80%.

Charging

Each battery pack experiences self-discharge during long-term storage.

- Battery packs should be inspected and recharged to 50% state of charge (SOC) every 3 to 6 months.
- Do not store the battery pack in a fully charged state for extended periods.
- If the battery pack is excessively discharged, it should be recharged using a low charging current. Otherwise, authorized personnel should be contacted.



Environmental Conditions

- Ensure that the storage environment is clean and dry before storing the battery pack.
- Protect the battery pack from dust and debris. If necessary, store it in a protective enclosure.
- The battery pack should be kept away from corrosive environments, such as acids, solvents, and saline moisture.

10.1 State of Charge (SOC) Calibration for Long-Term Storage

The battery pack should be placed in storage when not in use. If the storage period exceeds six months, the battery pack should be manually calibrated. Follow the procedures below to perform battery pack calibration:

- Charge the battery to 100% SOC.
(**Note:** *It may take longer for the battery to reach 100%.*)
- Discharge the battery to 15% SOC.
- Charge the battery to 100% SOC.



IMECAR

1200 Brickell Avenue, Suite 1950 Miami, FL 33131

usa@imecar.com

+1 (786) 575-3530