

# BATTERY PACK

## INSTALLATION MANUAL



**CAPACITY** : 5.4 kWh  
**MODEL NO** : LFP-010-005K  
**PUBLICATION DATE** : 26.08.2024  
**DOCUMENT CODE** : 054-KK002-00-1



## LEGAL NOTICES

© IMECAR. All rights reserved.

Unless otherwise stated, all names, logos, trademarks, and service marks referenced in this document are the property of IMECAR or are used under license by IMECAR.

The information contained in this document is provided for informational purposes only. IMECAR assumes no responsibility or liability for any damages, losses, or injuries resulting from the use of, or reliance on, the information herein.

IMECAR reserves the right to modify, update, or revise this document and its contents at any time without prior notice.

## INSTALLATION MANUAL

This User Manual has been prepared by IMECAR engineers for the Battery Pack. Please read this installation and operation manual thoroughly before using the battery pack. For assistance with any issues not addressed in this document, contact IMECAR engineers directly or via email through our website: <https://www.imecar.com>.



## TABLE OF CONTENTS

1	SAFETY	4
1.1	General Safety Instructions	4
1.2	Warning Symbols	5
1.3	Warning and Hazard Labels	5
2	EQUIPMENT REQUIREMENTS	6
3	PRE-INSTALLATION INSPECTION	6
4	CABLE SELECTION	6
5	INSTALLATION AND STORAGE ENVIRONMENT	6
6	BATTERY PACK INTRODUCTION	7
6.1	Battery Pack Safety Labels	7
7	TRANSPORTATION OF THE BATTERY PACK	8
7.1	General Transportation Requirements	8
7.2	Manual Handling Using Integrated Handles	8
8	INSTALLATION INSTRUCTIONS	9
8.1	Cable Connections	9



## Figures

Figure 1	5.4 kWh Battery Pack External View .....	7
Figure 2	Carrying Handles Overview .....	8
Figure 3	Battery Pack Cable Connection Points .....	9
Figure 4	Battery Pack Cable Connections .....	10
Figure 5	Optional On/Off Button.....	11

## Tables

Table 1	Environmental Conditions .....	6
---------	--------------------------------	---



# 1 SAFETY



## 1.1 General Safety Instructions

RULES	CAUTION
Always wear appropriate personal protective equipment (PPE), including eye protection and gloves.	Never wear jewelry or other metallic objects when working on or near the battery pack.
Always use insulated tools when performing work on the battery pack.	Never place any objects on the battery pack.
Always keep sparks, open flames, and sources of static electricity away from the battery pack.	The battery pack should be stored at approximately 30% state of charge (SOC). Ensure this value is maintained.
Always use appropriately sized, short cables to minimize voltage drop.	The battery pack temperature rises if the maximum charging current is exceeded. Never exceed the specified maximum charging current to ensure battery health and longevity.
Always ensure the charger is configured according to the recommended settings.	Never dispose of batteries as household waste. Recycle them in accordance with applicable regulations.
Always ensure that chargers are turned off or disconnected before performing work on the battery pack.	The battery pack may only be opened by IMECAR personnel. Unauthorized opening will void the product warranty.
Always follow the product warning labels and the battery pack instruction manual provided by IMECAR.	Do not use wet or dry pressure washers to clean the battery pack. Do not immerse the battery pack in water. Always protect the battery pack from contact with liquids.
Never subject the battery pack to physical damage, including drilling, dropping, crushing, burning, shaking, hammering, or improper terminal connections. Battery packs exposed to these conditions, even if no visible damage is present, must not be used.	Never short-circuit the terminals of the battery pack.
Always install the battery pack with the power off.	Never overcharge or over-discharge the battery pack.











## 1.2 Warning Symbols

Important warnings used in this document are listed below.

	Failure to observe this warning may result in serious injury or even death to personnel near the battery pack or during its handling.
	If ignored, this may result in serious injury.
	It may cause damage to the battery pack.

## 1.3 Warning and Hazard Labels

	<b>The “Refer to User Manual” symbol indicates the importance of the document information.</b> Do not install the battery pack before reading this document. Make sure you understand the warnings, installation steps and other information, otherwise unintentional actions may cause injury or death.
	<b>The “Warning” symbol indicates danger.</b> Failure to observe or incorrect application of procedures and practices may result in injury or death of installation personnel. Only after the specified conditions have been fully understood and fulfilled may the operation accompanied by the “electrical hazard” symbol be carried out.
	<b>The “Caution” symbol indicates danger.</b> Failure to observe or incorrect application of procedures and practices may result in damage or destruction of the product. Only after the specified conditions have been fully understood and fulfilled, the operation accompanied by the “caution” symbol can be carried out.
	<b>“Electrical hazard” indicates danger.</b> Failure to observe or incorrect application of procedures and practices may result in injury and death of installation personnel. Only after the specified conditions have been fully understood and fulfilled, the operation indicated by the symbol “Voltage hazard” may be carried out using personnel isolation equipment.
	<b>The symbol indicates electrical hazard.</b> Do not make physical repairs to the battery pack.
	<b>Indicates the collection and recycling of battery packs.</b> The collection and recycling of battery packs contributes to environmental protection and the conservation of material resources and enables the recovery of valuable materials.
	<b>The symbol indicates Li-ion battery waste.</b> Do not dispose of products containing Li-ion batteries with general products.
	<b>The symbol indicates moisture protection.</b> The product is affected by moisture. Therefore, make sure that the installation prevents moisture and that the system is located in a moisture-free, dry environment.



## 2 EQUIPMENT REQUIREMENTS

Before performing installation or maintenance of the battery pack, ensure that the following equipment is available and that all required safety precautions have been taken.

Equipment:

Insulated Hand Tool Set	Fasteners
Protective Goggles	Protective Clothing
Insulated Torque Wrench	Insulated Workbench
Insulated Gloves	Firefighting Equipment



Check that the equipment and tools used during installation are in good working condition.

## 3 PRE-INSTALLATION INSPECTION

Inspect the battery pack for visible damage, including cracks, dents, deformation, or other obvious anomalies.

If any issues are identified with the battery pack, contact IMECAR Technical Support or your authorized distributor. In the event of shipping-related damage, contact the shipping carrier.

Follow all procedures outlined in this User Manual for proper installation, operation, and storage.

If you have any questions or concerns regarding the installation or operation of the battery pack, contact IMECAR Technical Support prior to the occurrence of any issues.

## 4 CABLE SELECTION

Cables must be properly sized to carry the expected electrical load and be of sufficient length and flexibility to prevent unintended mechanical stress on the connector interfaces.

## 5 INSTALLATION AND STORAGE ENVIRONMENT

Installation and storage of the battery pack must be performed in a clean, dry, and moisture-free environment. Any contact with liquids must be avoided.

The recommended environmental conditions for battery pack installation are listed in Table 1.

The accumulation of dust or sand inside the equipment may result in premature damage. Therefore, the environmental conditions listed in the table below should be considered when selecting the battery pack installation site.

Table 1 Environmental Conditions

Environmental Conditions	Recommended Range
Environmental Temperature	-20°C – 55°C (-4°F – 131°F)
Humidity	80% relative humidity, no condensation
Dust Level	≤ 1 mg/m <sup>3</sup>
Abrasive Materials	The environment must not contain pollutants such as salt, acid, smoke, etc.
Vibration	≤ 1.5 mm/s



## 6 BATTERY PACK INTRODUCTION

Before installing the battery pack, carefully review this introductory section. This section provides an overview of the battery pack layout and identifies the locations of the power connection ports, communication ports, control interfaces, air valve, and mounting points as shown in the figure below.

The battery pack is equipped with HV (+), HV (-), and Low Voltage (LV) communication socket outputs. All cable connections shall be connected to the corresponding sockets as indicated in the figure. Incorrect or improper connections may result in system malfunction, equipment damage, or safety hazards.

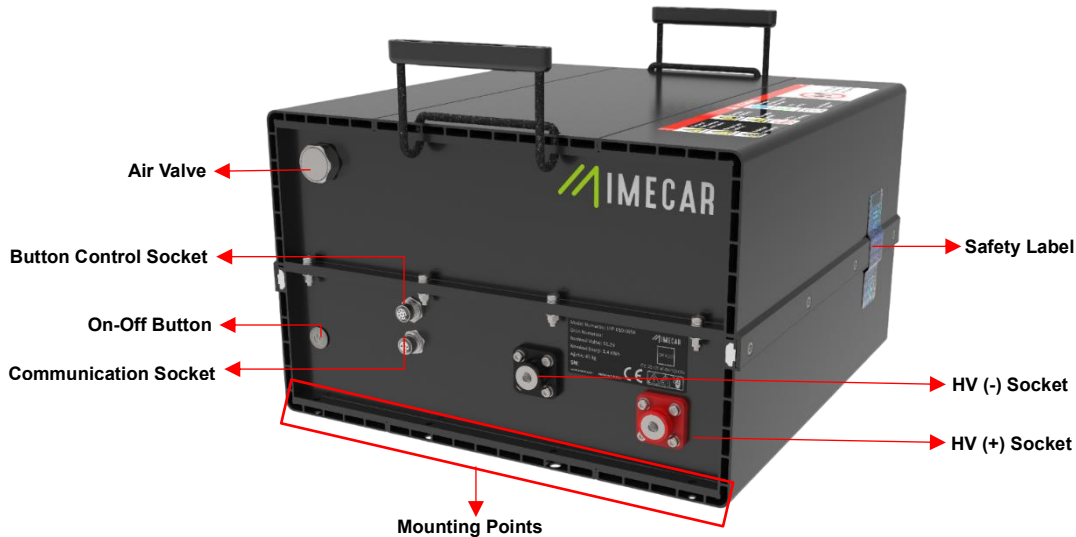

Figure 1 5.4 kWh Battery Pack External View



- Cable connections are critically important. Incorrect connections may cause severe damage to the battery pack or any components connected to it. This can also lead to serious injury or death to individuals near the component.
- The battery pack must be installed by qualified and authorized personnel only.

### 6.1 Battery Pack Safety Labels

As shown in *Figure 1 – 5.4 kWh Battery Pack External View*, the battery pack is equipped with a Safety Label for user protection and hazard awareness.

- The Safety Label indicates that the battery pack contains high-voltage and energy storage components and must be handled with care.
- Only authorized and qualified personnel are permitted to install, service, inspect, or perform any intervention on the battery pack.
- The Safety Label is provided solely for safety and warning purposes and forms an integral part of the product's safety system.
- The Safety Label must not be removed, damaged, altered, or covered under any circumstances.
- If the Safety Label becomes damaged or unreadable, the battery pack must not be operated until the label is replaced.

Failure to comply with the instructions indicated by the Safety Label may result in serious injury, electric shock, fire hazard, or voiding of the product warranty.



## 7 TRANSPORTATION OF THE BATTERY PACK

The battery pack is a high-energy lithium-ion system and must be handled with extreme care during transportation. Improper handling may result in serious personal injury, equipment damage, or hazardous conditions.

### 7.1 General Transportation Requirements

- The battery pack shall be transported only by trained and authorized personnel.
- The battery pack shall be transported in its original packaging or equivalent protective packaging designed to prevent impact, vibration, and mechanical stress.
- The battery pack must not be dropped, dragged, tilted excessively, or subjected to shock during handling or transportation.
- The battery pack shall be transported at approximately 30% state of charge (SOC) in accordance with dangerous goods transportation regulations.
- Transportation in wet, humid, excessively hot, or extremely cold environments is strictly prohibited.
- All HV (+) and HV (-) terminals must remain disconnected, covered, and electrically insulated during transportation.

### 7.2 Manual Handling Using Integrated Handles

- The battery pack is equipped with integrated carrying handles specifically designed to support the full weight of the battery pack during manual handling.
- The battery pack must be lifted, carried, and positioned only by holding these designated handles.
- Lifting or carrying the battery pack by cables, connectors, terminals, mounting points, housings, or any non-designated structural parts is strictly prohibited.
- A firm and balanced grip on all available handles must be maintained at all times to ensure stability and prevent dropping.
- When manual lifting is required, personnel shall follow proper ergonomic lifting practices and ensure adequate manpower is available to safely support the battery pack weight.

Failure to carry the battery pack using the designated handles may result in loss of control, damage to internal battery cells, electrical hazards, or serious personal injury.

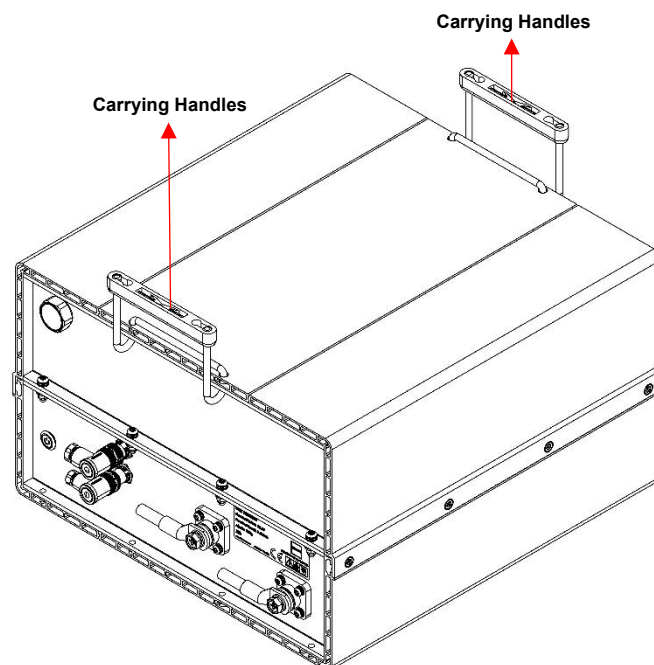

Figure 2 Carrying Handles Overview



## 8 INSTALLATION INSTRUCTIONS

After carefully reviewing the safety precautions listed under this heading and taking the necessary measures, the installation process may be initiated in accordance with the specified steps. All warnings and cautions provided throughout this document must be observed and complied with.



- Install the battery pack in a safe and controlled environment.
- Keep the battery pack free from dust, debris, and foreign contaminants during operation.
- The battery pack must be installed, removed, or repaired only by a licensed electrician.



Ignoring or disregarding the safety instructions and warnings in this manual, as well as those printed on the battery pack, may result in electric shock, fire, and/or serious injury.

### 8.1 Cable Connections

Refer to the numbered components shown in the figure when connecting the cables.

All connections shall be performed only by authorized personnel and with the battery pack powered OFF.

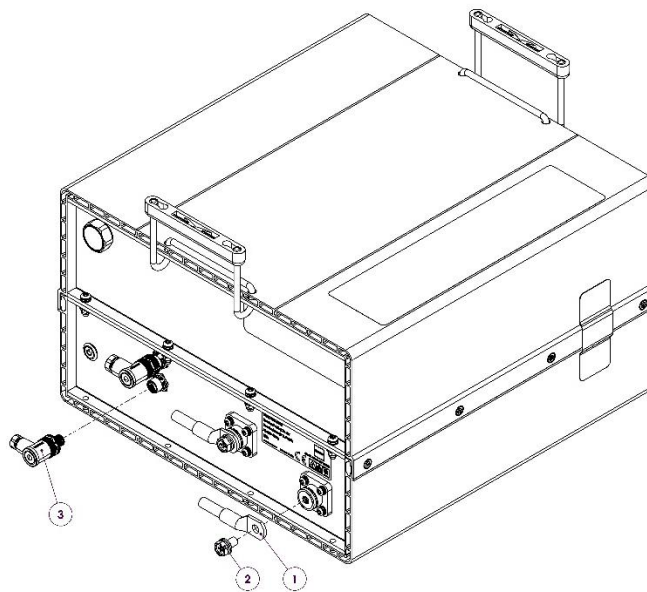

Figure 3 Battery Pack Cable Connection Points

#### ➤ HV Power Terminal

This is the high-voltage power terminal (1, 2) on the battery pack where the main power cable is connected.

#### ➤ HV Power Cable Lug / Fastener

Attach the power cable lug to the HV terminal (1) and tighten the fastener securely.

Make sure the connection is fully seated and does not move.



### ➤ Communication Socket

Connect the communication (CAN) connector to this socket (3). Ensure it is fully inserted and locked.

After completing connections, verify that all connectors are secure and cables are not under tension before powering ON the battery pack.

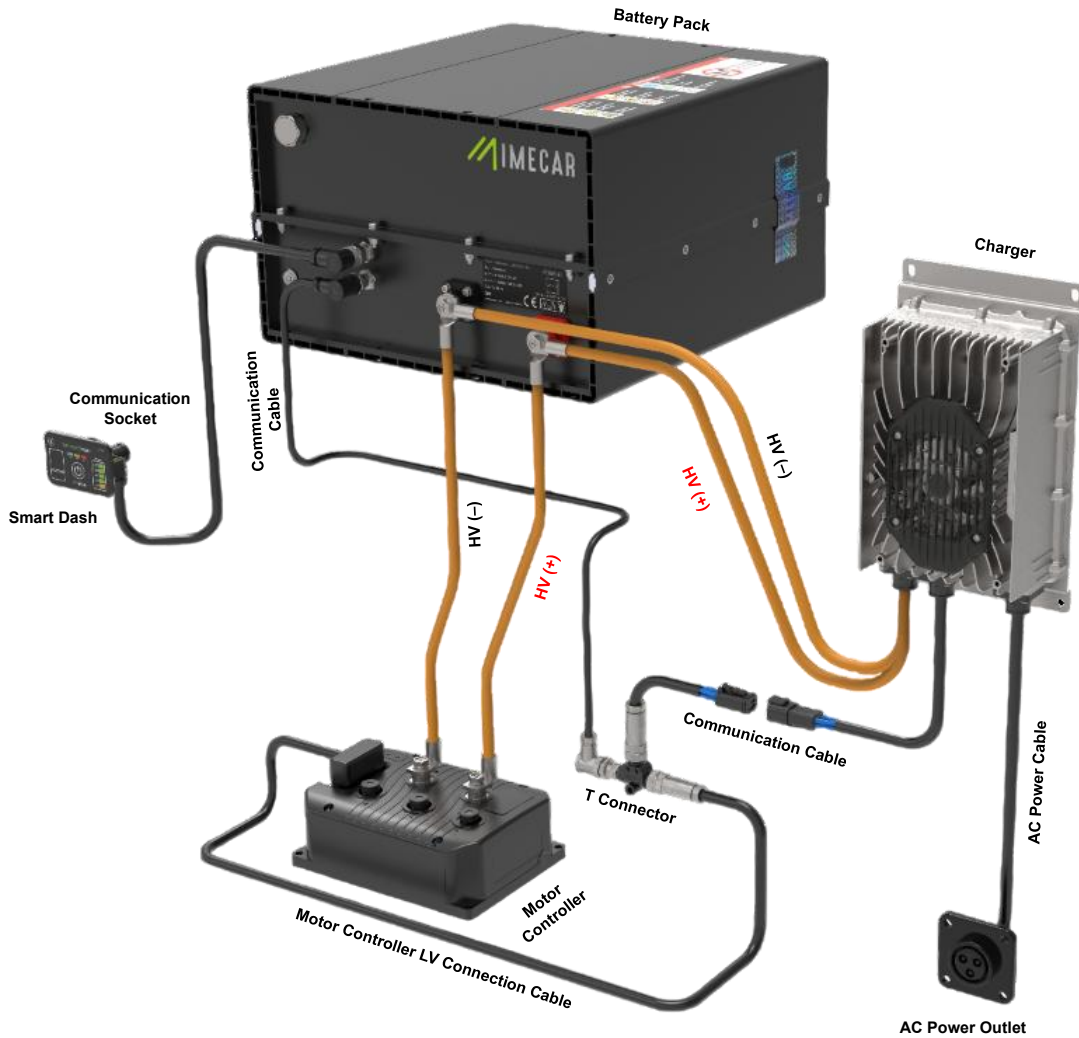

Figure 4 Battery Pack Cable Connections



### ➤ **Optional On/Off Button**

As an alternative to the Smart Dash unit, an optional On/Off Button may be supplied upon customer request. This component is intended for systems where the Smart Dash is not installed.

The On/Off Button enables manual activation and shutdown of the battery pack.

The cable assembly connects directly to the battery pack control/communication port.

For wiring and connection details, refer to Section 8.1 - Cable Connections.

This product is optional and provided only upon request.

If the optional On/Off Button is used, installation and operation must be performed strictly in accordance with the instructions in this manual.

Failure to follow the installation instructions may result in system malfunction or equipment damage.

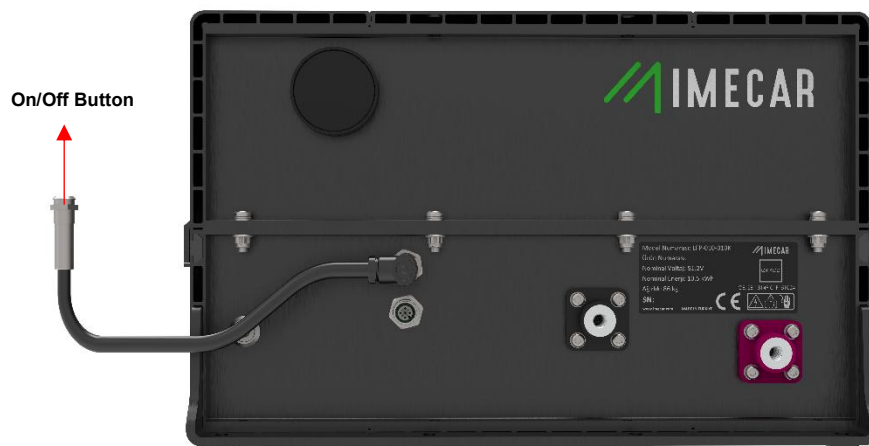

Figure 5 Optional On/Off Button



IMECAR

1200 Brickell Avenue, Suite 1950 Miami, FL 33131

[usa@imecar.com](mailto:usa@imecar.com)

+1 (786) 575-3530